



zogics | **FLOORING**

STACKED ROLLED RUBBER FLOORING

PRODUCT BROCHURE



ZOGICS STACKED ROLLED RUBBER FLOORING

Zogics Stacked Rolled Rubber Flooring is built to maximize comfort during training while minimizing the shock of impact. Offered in 3 thicknesses and a variety of color options, our Stacked recycled rubber is versatile to meet the needs of any and every facility.

Like our other rubber flooring, customers can combine custom graphics and waterjet logos for more brand recognition and consistency.

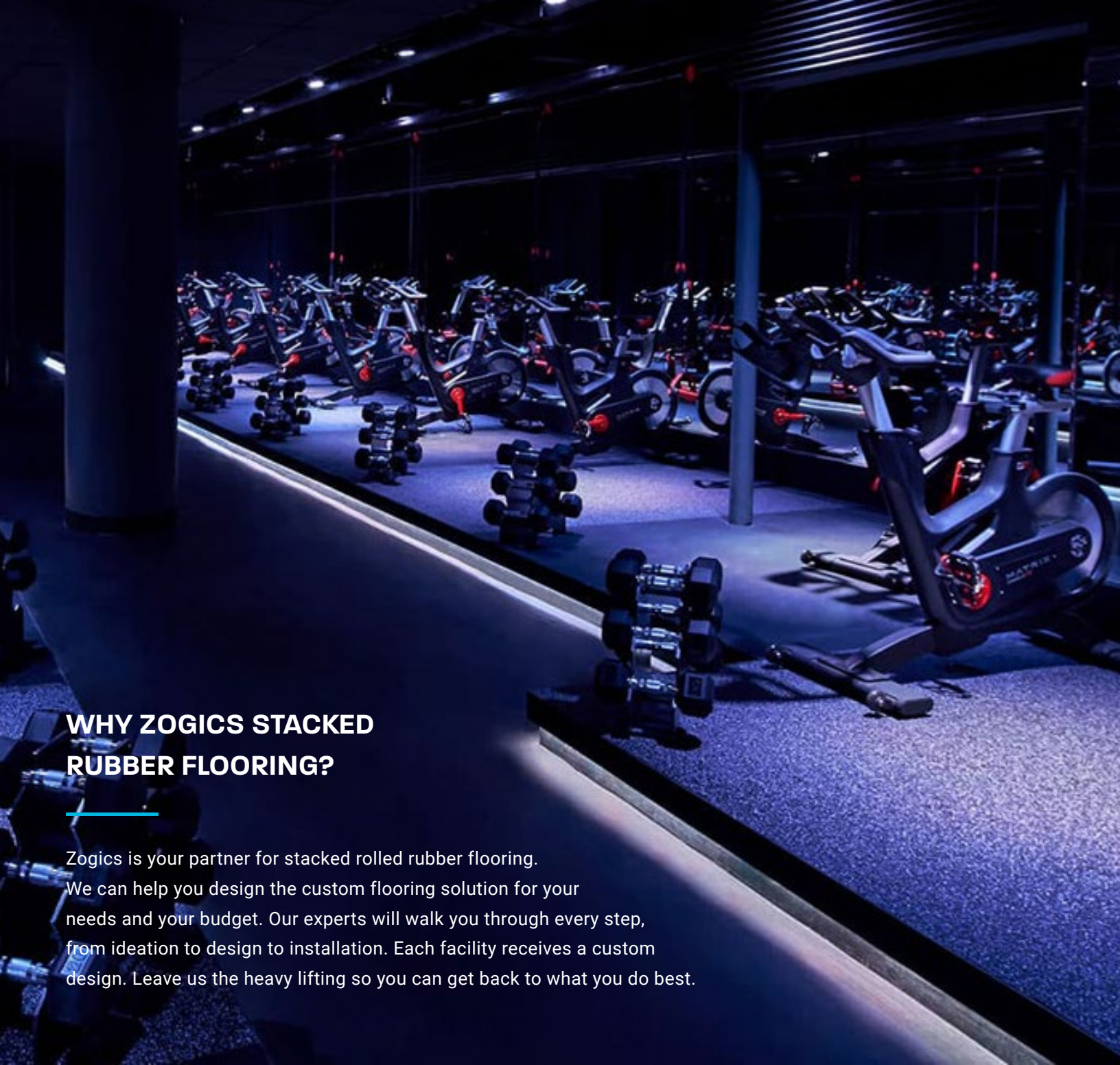

WHY ZOGICS STACKED RUBBER FLOORING?

Zogics is your partner for stacked rolled rubber flooring. We can help you design the custom flooring solution for your needs and your budget. Our experts will walk you through every step, from ideation to design to installation. Each facility receives a custom design. Leave us the heavy lifting so you can get back to what you do best.



Dual Layer for Minimum Shock Impact



Quickest Lead Time & Easiest Quoting



Full Design Staff for Layout



Custom Branding Available



100% Recycled Rubber



5-Year 100% Warranty

COLORS

Match your facility's look and design with a wide range of color options. Our flooring is available in three color sets, Core, Flex, and Fit:

CORE



Core colors are solid and lightly patterned flecks colors. The color fleck is embedded throughout the entire thickness in rolled rubber flooring.

FLEX

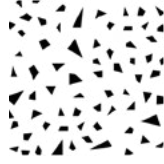

Flex colors adds more flecks into the color mix. These colors, when viewed as a large floor, read as the most patterned rubber flooring.

FIT

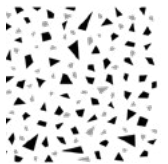

Fit adds the most flecks into the rubber flooring, moving away from a black floor and reading as a solid color. Mixing Core, Flex, & Fit colors



Core Black

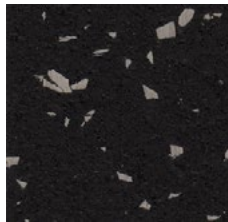

Core Gray



Core Iron

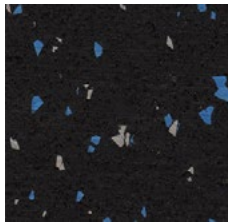

Core Smoke

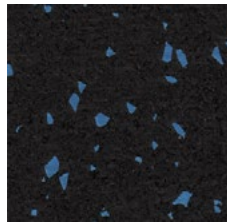

Core Cobalt

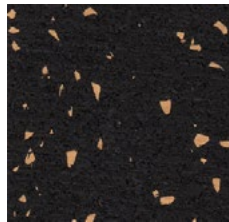

Core Sand



Core Volcano

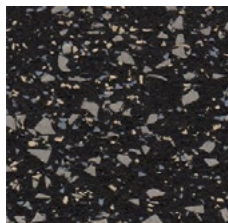

Flex Slate

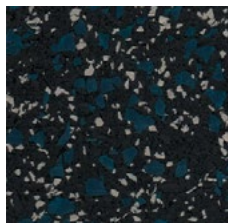

Flex Mineral

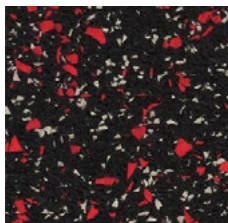

Flex Flame

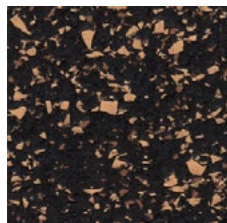

Flex Buff



Fit Steel

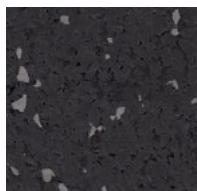

Fit Charcoal



Fit Asphalt



Fit Copper

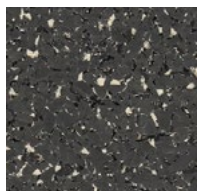

Fit Gunmetal

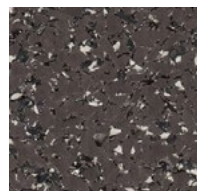

Fit Haze

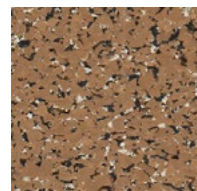

Fit Desert



Fit Pewter

3 THICKNESS OPTIONS

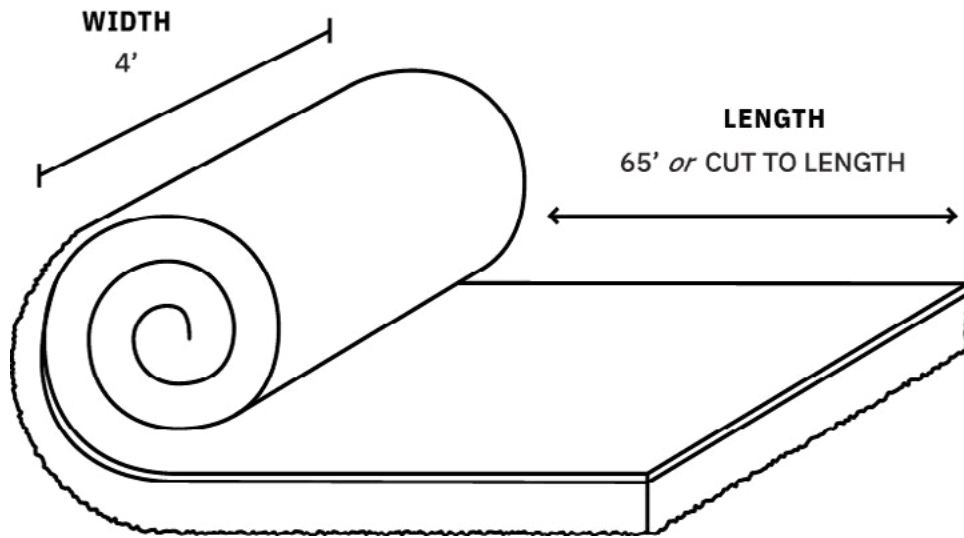
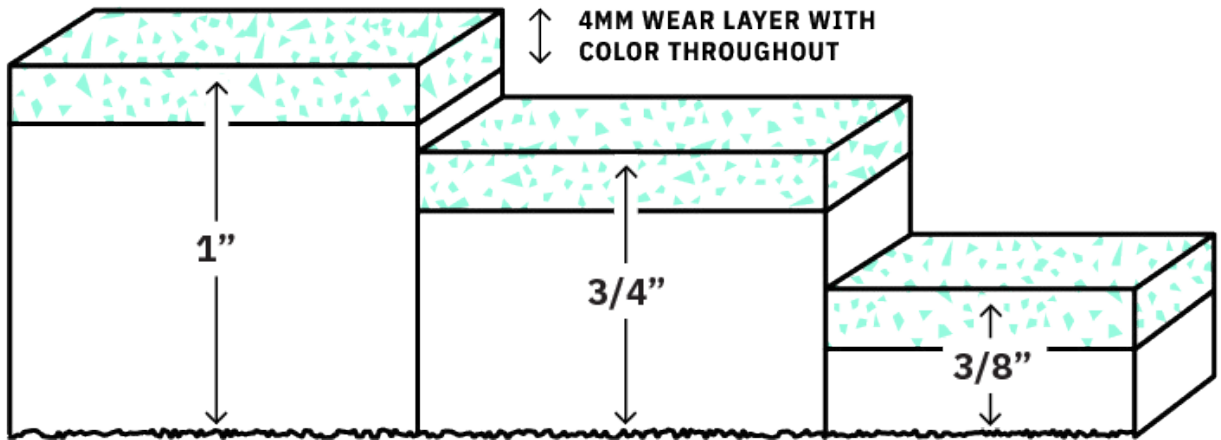

FEATURES

- Two Layers of Rubber Fused Together
 - Top Layer 25% Thicker Than Competitors
 - Max Comfort, Minimum Shock Impact
 - Slip Resistant (wet or dry)
 - Easy Installation
 - Seamless Appearance
 - 5-Year Warranty
 - Ability to Add Logo or Branding
 - Made in the USA
- (minimums apply)

SPECIFICATIONS

- **Thickness:** 3/8", 3/4", 1"
 - **Roll Width:** 4' (48')
 - **Roll Length:** Standard 65',
Custom cuts available at no charge
- NOTE: Minimum Order of 100 sq/ft

MARKET APPLICATIONS

- Fitness Flooring
- Health Clubs
- Indoor Recreation
- Functional Training
- Weight Rooms

TECHNICAL CHARACTERISTICS

| PERFORMANCE | STANDARD | 3/8" THICKNESS | 3/4" THICKNESS | 1" THICKNESS |
|-------------------------|------------|-----------------------------|-----------------------------|-----------------------------|
| Roll Construction | | Double-Ply, Field Laminated | Double-Ply, Field Laminated | Double-Ply, Field Laminated |
| Roll Width | | 48" | 48" | 48" |
| Roll Length | | 65' (custom cuts available) | 65' (custom cuts available) | 50' (custom cuts available) |
| Weight | | 2.05 lb per sq/ft | 3.47 lb per sq/ft | 4.62 lb per sq/ft |
| Tolerances | | Thickness: +.5mm -.5mm | Thickness: +.5mm -.5mm | Thickness: +.5mm -.5mm |
| | | Width: +1/2" - 0 | Width: +1/2" - 0 | Width: +1/2" - 0 |
| Wear Surface Density | | 75-80 lbs per cubic ft. | 75-80 lbs per cubic ft. | 75-80 lbs per cubic ft. |
| Tensile Strength | ASTM D412 | >220 PSI | >210 PSI | >210 PSI |
| Tear Strength | ASTM D624 | 80 Pli. Min. | 80 Pli. Min. | 80 Pli. Min. |
| Flexibility | ASTM F137 | Pass | Pass | Pass |
| Hardness (Shore A) | ASTM D2240 | 63 +/-5 | 63 +/-5 | 63 +/-5 |
| Coefficient of Friction | ASTM D2047 | Dry = 1.10/Wet = 0.95 | Dry = 1.10/Wet = 0.95 | Dry = 1.10/Wet = 0.95 |
| Pill Flammability | ASTM F1514 | Pass | Pass | Pass |
| Resistance to Light | ASTM F1515 | Pass | Pass | Pass |
| Resistance to Chemicals | ASTM F925 | No Change | No Change | No Change |
| Resistance to Heat | ASTM F4060 | Pass | Pass | Pass |



Still have questions?
We love to help!